

Steampunk Airship

Стімпанк Дірижабль

FRA Dirigeable steampunk
DEU Steampunk-Luftschiff SPA Dirigibile
Steampunk ITA Dirigibile Steampunk
JPN スチームパンクエアシップ CHI 蒸汽朋克
飞艇 POR Dirigível Steampunk POL Sterowiec
steampunkowy KOR 스팀펑크 비행선

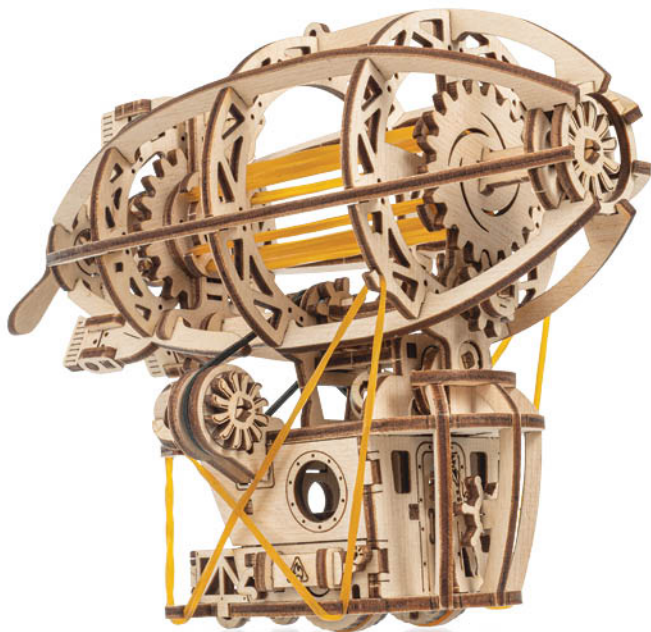

Find out MORE

Assemble me. Take to the skies for grand adventures!

Assembly instructions
Інструкція зі складання

FRA Notice d'assemblage. DEU Aufbauanleitung. SPA Instrucciones de montaje.
ITA Istruzioni di montaggio. JPN 組み立て説明書 CHI 装配说明书
POR Instruções de montagem. POL Instrukcja montażu. KOR 조립 설명서.

ENG Assembly instructions:

Remove model parts from the hanger board as illustrated below. Careful not to break parts. If a part does not remove easily, carefully cut it out with a knife. This model is intended for self-assembly without glue. If you have difficulty installing the axles, try waxing them with a regular candle. All moving parts can also be waxed during assembly to reduce friction when operating the model.

UKR Інструкція зі складання:

Витягніть з дошки позначені на схемі деталі. Намагайтеся їх не зламати. Якщо деталь не виймається, надсічіть перемички ножем. Конструкція збирається без клею. У разі виникнення труднощів з протягуванням вісі в отвір, потріть деталь об звичайну свічку. Також можна змастити свічкою всі деталі механізму, що рухаються, щоб зменшити тертя при обертанні.

FRA Notice d'assemblage:

Faites sortir de la planche les pièces comme indiquées sur le schéma. Tâchez de ne pas les casser. Si la pièce ne sort pas, incisez les collages/fixations avec un couteau. La construction est à assembler sans colle. Si il est difficile d'introduire l'axe en bois dans l'orifice, frottez au préalable l'axe ou les pièces contre une bougie. Pour améliorer le glissement, traitez les pièces de frottement mobiles du mécanisme avec une bougie au cours d'assemblage.

DEU Aufbauanleitung:

Bitte die in der Zeichnung angegebenen Teile aus der Platte herausnehmen. Versuchen Sie bitte diese nicht zu brechen. Wenn sich ein Teil nicht herausnehmen lässt, schneiden Sie die Stege mit dem Messer leicht an. Das Modell wird ohne Klebstoffe zusammengesetzt. Lässt sich eine Achse nur schwer in eine Öffnung einführen, reiben Sie diese mit einer Kerze etwas ein. Für besseres Gleiten schmieren Sie alle beweglichen Teile mit einer Kerze.

SPA Instrucciones de montaje:

Saque de la tabla las piezas marcadas en el esquema. Trate de no romperlas. Si una pieza no se saca, haga una incisión. La construcción va sin pegamento. Si tiene dificultades con la instalación del eje de madera en un agujero, frote primero el eje o las piezas contra una vela. Para un mejor deslizamiento, lubrique durante el montaje las piezas móviles del mecanismo con una vela común.

ITA Istruzioni di montaggio:

Estrarre dal telaio i particolari indicati nello schema. Fare attenzione a non romperli. Se un particolare non si stacca, tagliare delicatamente gli elementi di collegamento con un coltello. L'assieme viene realizzato senza colla. In caso di difficoltà nell'inserimento di un perno in legno, è necessario sfregare il perno o il particolare con un po' di cera. Per uno scorrimento migliore incerare le parti mobili del meccanismo durante l'assemblaggio.

JPN 組み立て説明書:

部品に傷をつけないよう注意しながらボードから外してください。部品が外れにくい場合は連結部分をカッターで切ってから外すと外しやすいです。本製品は、接着剤がなくても組み立てができるように設計されています。もしアクスル(駆動部)が、歯車の動きがにびい場合は、口ウソクをアクスルに塗ってください。全ての駆動部分は製品を動かす時、滑らかに動くように潤滑剤である口ウソクを塗りながら組み立てます。

CHI
装配说明

将模型部件按插图示，从胶合板取下。小心不要损坏件。如果取下时候有难度，请用小刀小心的切割连接点。这个产品不需要胶水粘接。如果安装转轴的时候有难度，请用普通的蜡加以润滑。所有的转动部分也需要打蜡润滑。

POR
Instruções de montagem:

Remova as peças do modelo da placa de suporte conforme ilustrado abaixo com cuidado para não quebrá-las. Se uma peça não puder ser removida facilmente, corte-a cuidadosamente com uma faca. Este modelo foi feito para ser montado de forma prática, sem precisar usar cola. Se você tiver dificuldade em instalar os eixos, tente passar um pouco de cera, como por exemplo, a de uma vela comum. Todas as peças móveis também podem ser enceradas durante a montagem para reduzir o atrito ao operar o modelo.

POL
Instrukcja montażu:

Delikatnie wyciągaj z deseczki wskazane w schemacie detale, starając się nie połamać elementów. Jeśli detal nie poddaje się, podetnij wiązadła nożem. Konstrukcje składa się bez kleju. Jeśli napotkasz trudności z instalacją drewnianej osi w otwórze, potrzyj na początku oś lub detale o woskową świecę. Dla lepszego poślizgu polecano smarowanie ruchomych części mechanizmu zwykłą świecą podczas montażu

KOR
조립 설명:

부품이 손상되지 않도록 주의하여 보드에서 떼어냅니다. 만약 부품이 잘 떨어지지 않으면 연결 부분을 칼로 절단한 후 떼어내면 쉽게 떼어 낼 수 있습니다. 본 제품은 접착제가 없이 조립이 가능하도록 설계되어 있습니다. 만약 축이 잘 끼워지지 않는 경우 양초를 축에 바른 후 끼워 보세요. 모든 구동 부위는 제품 구동 시 원활한 작동이 가능하도록 조립 과정에서 윤활제(양초)양초를 발라 주세요.

ENG Warning! UKR Увага! FRA Attention! DEU Achtung! SPA Precaución! ITA Attenzione! JPN 注意!
CHI 注意! POR Atenção! POL Uwaga! KOR 주의!



ENG Do not use a lighted candle! **UKR** Не підпалювати! **FRA** Ne pas brûler!
DEU Nicht anzünden! **SPA** ¡No encender! **ITA** Non dare fuoco!
JPN 火のついた口ウソクの使用はお止めください。 **CHI** 请勿点燃，请勿靠近火源！
POR Não use uma vela acesa!
POL Nie podpalać! **KOR** 불이 붙은 초를 이용하지 마세요!

ENG Customer support **UKR** Служба підтримки **FRA** Service client **DEU** Kundendienst
SPA Servicio al cliente **ITA** Servizio di supporto **JPN** お客様窓口 **CHI** 客戶支持
POR Atendimento ao cliente **POL** Wsparcie klienta **KOR** 고객센터

customerservice@ugearsmodels.com

ENG Symbols. **UKR** Умовні позначення. **FRA** Légende. **DEU** Legende. **SPA** Leyenda. **ITA** Legenda. **JPN** 記号
CHI 图标含义 **POR** Símbolos. **POL** Oznaczenia umowne. **KOR** 기호.



ENG Pay attention. Check position of the part. **UKR** Зверніть увагу. Перевірте розташування елемента. **FRA** Faites attention. Vérifiez la disposition de l'élément. **DEU** Bitte Beachten. Prüfen Sie die Einbaulage des Elementes. **SPA** Atención. Compruebe la situación del elemento. **ITA** Prestare attenzione. Controllare la posizione del componente. **JPN** 方向及び位置に注意して組み立ててください。 **CHI** 注意！检查部件方向和位置 **POR** Preste atenção. **POL** Zwróć uwagę. Sprawdź lokalizację elementu. **KOR** 방향 또는 위치에 주의해서 조립해 주세요.



ENG Sand to remove burrs. **UKR** Видалить задирки. **FRA** Éliminez les bavures. **DEU** Grate entfernen. **SPA** Quite las rebabas. **ITA** Togliere le bave. **JPN** バリ取りのサンドペーパー **CHI** 磨掉毛刺 **POR** Lixe para remover as rebabas. **POL** Usuń zadziory. **KOR** 거친 부분을 다듬어 주세요.



ENG Wax the part with a regular candle (rub with a candle). **UKR** Змастіть деталь звичайною свічкою (потріть об свічку). **FRA** Lubrifiez la pièce avec une bougie ordinaire (frottez contre la bougie). **DEU** Reiben Sie das Teil mit einer einfachen Kerze etwas ein. **SPA** Engrase la pieza con una vela común (frote con una vela). **ITA** Incerare il componente (Sfregare con la cera). **JPN** ざれた部分に潤滑剤としてロウソクを塗ってください。 **CHI** 用普通蜡烛涂抹润滑部件 **POR** Encere a peça com uma vela comum (esfregue com uma vela). **POL** Przesmaruj zwykłą świecą. **KOR** 표시된 부분에 윤활을 위해 초를 칠해 주세요.



ENG Check the mechanism for smoothness and accuracy of movement. Operate the mechanism so the parts would seat-in. **UKR** Перевірте механізм на плавність і точність ходу. Розробіть механізм. **FRA** Vérifiez si le mécanisme fonctionne en douceur et avec précision. Faites fonctionner le mécanisme jusqu'à son fonctionnement normal. **DEU** Prüfen sie den Mechanismus bezüglich der Laufruhe und der Genauigkeit des Ganges. Betätigen Sie den Mechanismus mehrmals. **SPA** Verifique la suavidad y precisión del mecanismo. Desarrolle el mecanismo.

ITA Controllare la scorrevolezza e la precisione del movimento. Far funzionare il meccanismo. **JPN** 駆動部分が滑らかに動くかを確認しながら作業をすすめます。 **CHI** 检查机构的运行平稳度和精密度。调整机构。 **POR** Teste a suavidade e precisão do movimento do mecanismo. Opere o mecanismo para que as peças se encaixem. **POL** Sprawdź płynność i dokładność ruchu mechanizmu. Dopracuj mechanizm. **KOR** 구동 부분의 원활한 작동과 정확한 움직임을 확인하세요.



ENG Spare parts. **UKR** Запасні деталі.
FRA Pièces de rechange.
DEU Ersatzteile. **SPA** Piezas de repuesto.
ITA Pezzi di ricambio. **JPN** 予備部品。
CHI 备用件。 **POR** Peças de reposição.
POL Części zamienne.
KOR 여유 부품입니다.

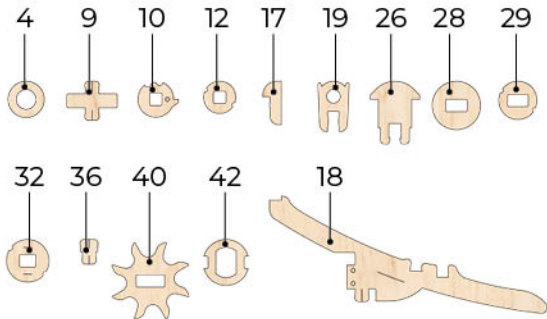

ENG Clean the burrs on the parts using the universal "Helper" (H) instrument. **UKR** Очистіть задирки на деталях за допомогою універсального інструменту «Helper» (H). **FRA** Nettoyez les bavures sur les pièces à l'aide de l'outil universel « Helper » (H). **DEU** Entfernen Sie die Grat an den Teilen mit dem "Helper" Universalwerkzeug (H). **SPA** Limpie las rebabas de las piezas utilizando la herramienta universal "Helper" (H). **ITA** Pulisci le sbavature residue sui pezzi utilizzando l'utensile universale "Helper" (H). **JPN** 万能器具「ヘルパー」(H)を使って、部品のバリを掃除する。 **CHI** 用通用的“帮手”(H)仪器清理零件上的毛刺。 **POR** Limpar as rebabas das peças com o instrumento universal "Helper" (H). **POL** Oczyszczyć zadziory na częściach za pomocą uniwersalnego narzędzia "Helper" (H). **KOR** 유니버설 헬퍼 (H)를 사용하여 불순물을 제거하세요.



ENG This is not a structural component; it is a tool for measurement and assembly. **UKR** Це не деталь конструкції, а допоміжний інструмент для складання або вимірювання відстаней. **FRA** Cette pièce ne

fait pas partie de la construction mais constitue un outil annexe pour l'assemblage ou la mesure des distances. **DEU** Es ist kein Teil der Konstruktion, sondern ein Hilfselement für den Zusammenbau oder für das Messen der Abstände. **SPA** No es una pieza de la construcción sino un instrumento auxiliar para montar o para medir distancias. **ITA** Non è un componente del modello, ma un'attrezzatura aggiuntiva per il montaggio o il rilievo delle quote. **JPN** この部品は完成時の部品ではなく、組み立てをサポートしたり測定する道具です。

CHI 这不是装配零部件，是一种测量及安装辅助工具。 **POR** Este não é um componente estrutural, é uma ferramenta para medição e montagem. **POL** To nie detal konstrukcji, a pomocnicze narzędzie dla montażu i wymiaru odległości. **KOR** 이 부품은 조립을 위한 부품이 아니고 조립을 돕거나 측정을 위한 도구입니다.

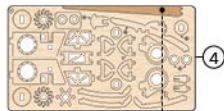

Mechanical models

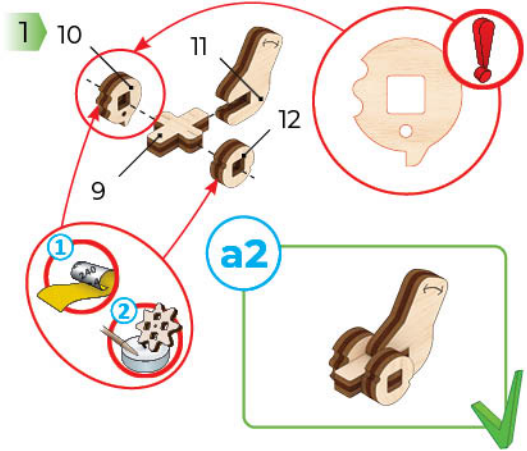
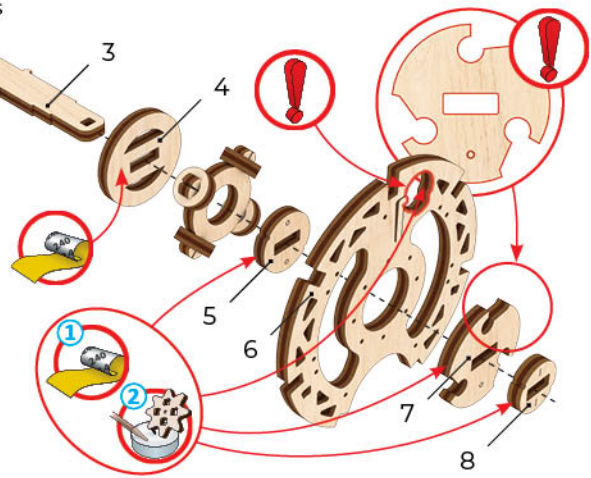
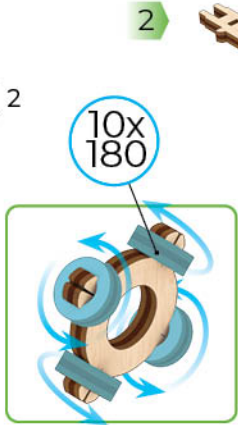
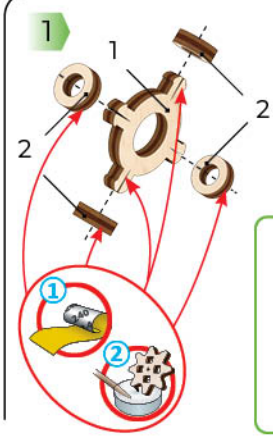

1

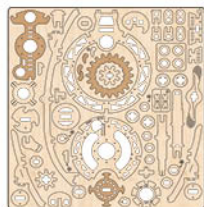

1

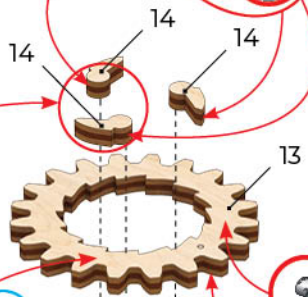

a2

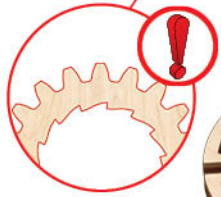

a1

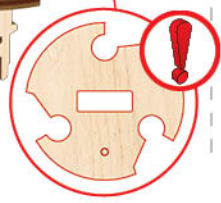

2

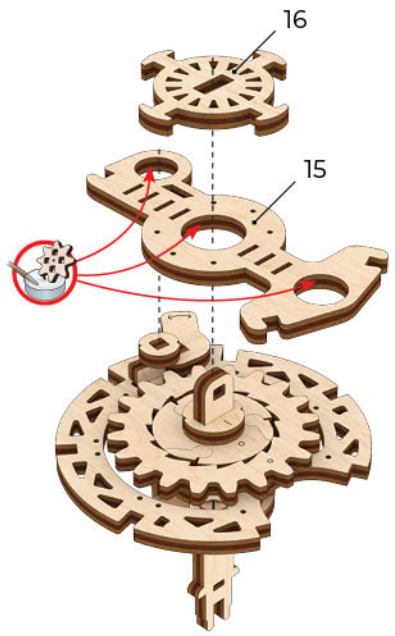

Mechanical models



3

H

17

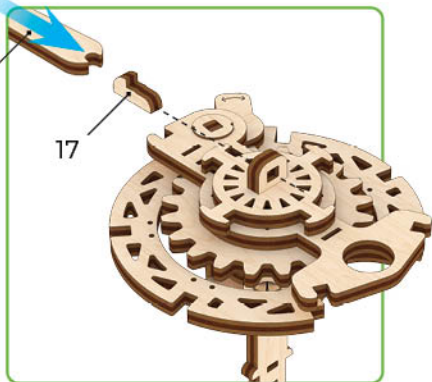

a3

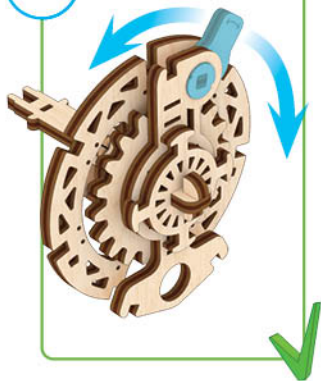

1

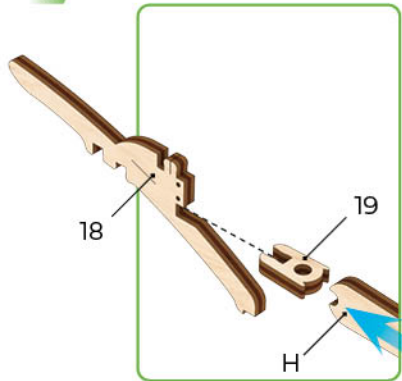

2

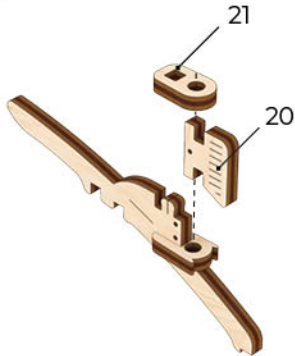

a4

X2



1

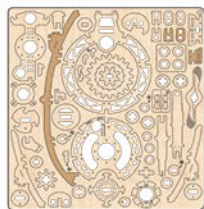
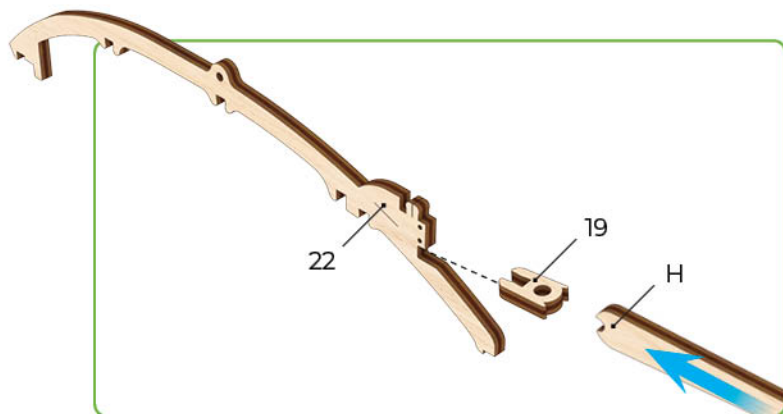

①

2

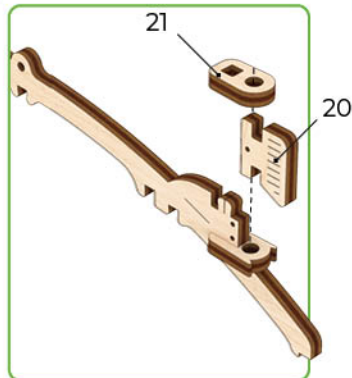

a5



9

1

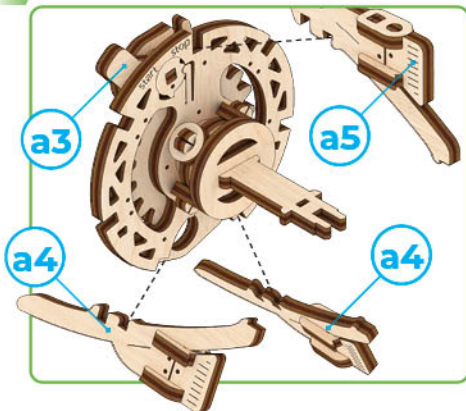

2

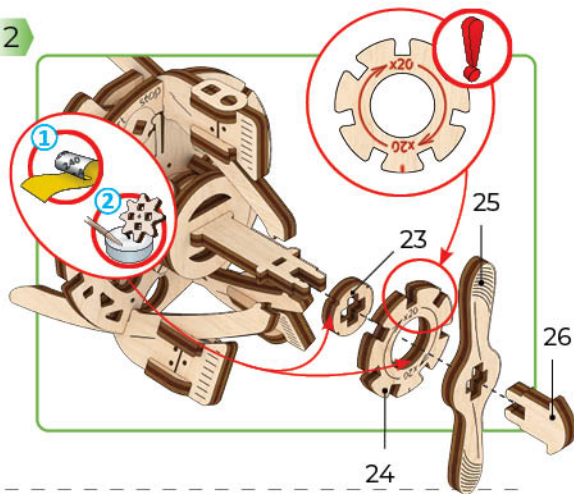

①

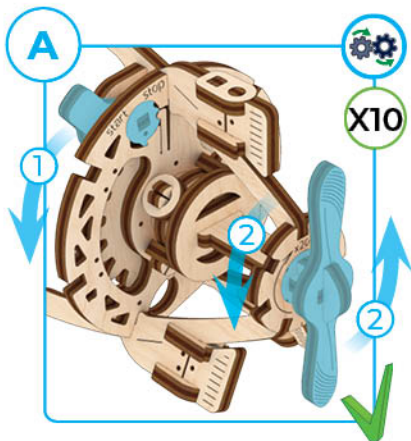

ENG Check the mechanism for smoothness and accuracy of movement. Operate the mechanism so the parts would seat-in.

UKR Перевірте механізм на плавність і точність ходу. Розробіть механізм.

FRA Vérifiez si le mécanisme fonctionne en douceur et avec précision. Faites fonctionner le mécanisme jusqu'à son fonctionnement normal. **DEU** Prüfen Sie den Mechanismus bezüglich der Laufruhe und der Genauigkeit des Ganges. Betätigen Sie den Mechanismus mehrmals. **SPA** Verifique la suavidad y precisión del mecanismo. Desarrolle el mecanismo. **ITA** Controllare la scorrevolezza e la precisione del movimento. Far funzionare il meccanismo. **JPN** 駆動部分が滑らかに動くかを確認しながら作業をすすめます。 **CHI** 检查机构的运行平稳度和精确度。调整机构。 **POR** Teste a suavidade e precisão do movimento do mecanismo. Opere o mecanismo para que as peças se encaixem. **POL** Sprawdź płynność i dokładność ruchu mechanizmu. Dopracuj mechanizm. **KOR** 구동 부분의 원활한 작동과 정확한 움직임을 확인하세요.



1

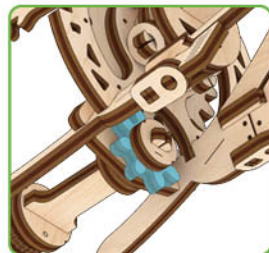
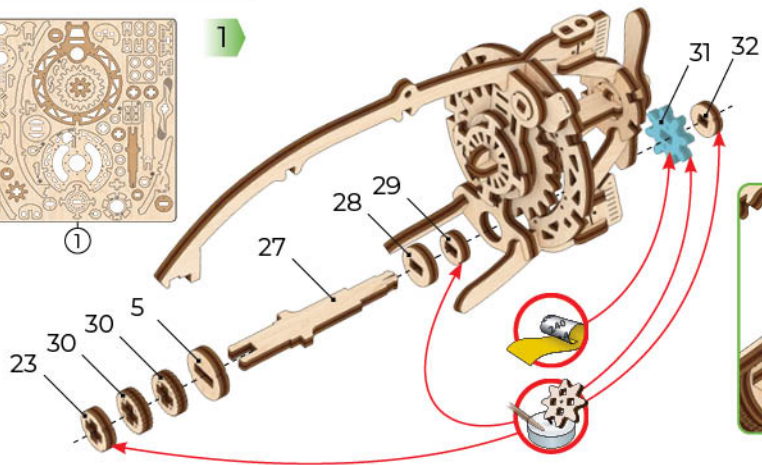

2

X2

$h = 0.05'' / 1,5 \text{ mm}$
 $D = 1.57'' / 40 \text{ mm}$

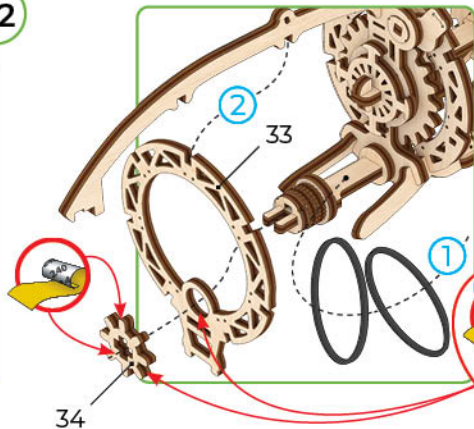
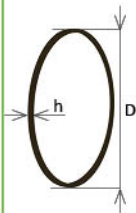

b1



11

Mechanical models

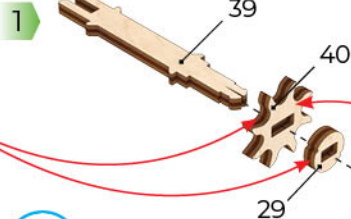
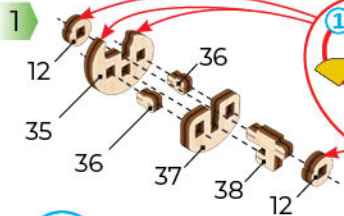

b2



b3

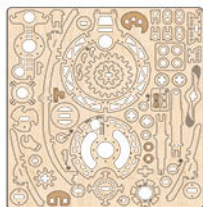
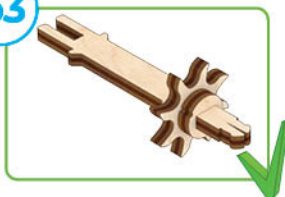

1

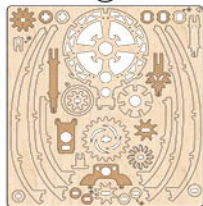

2

1

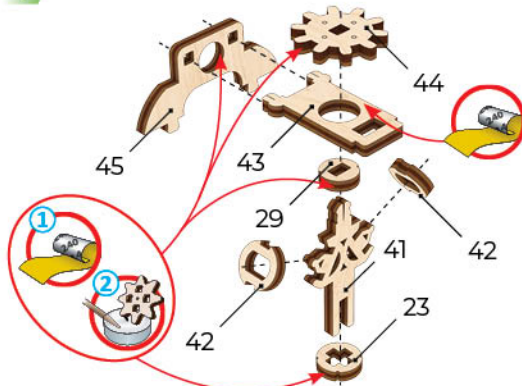

b4



12

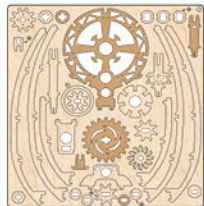

1

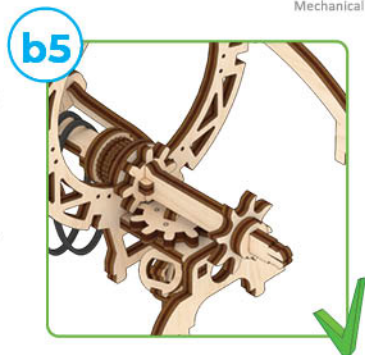
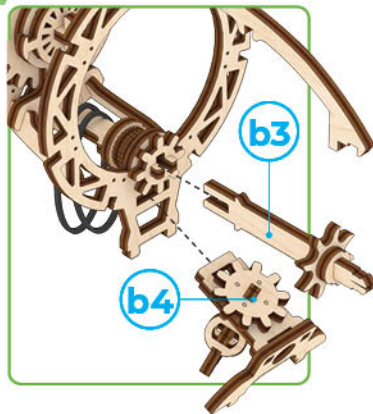

1

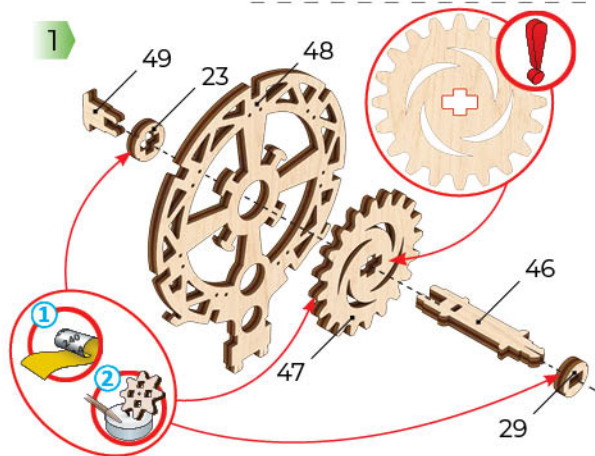

b6



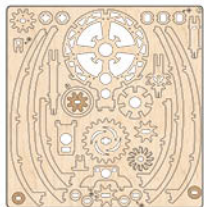

②

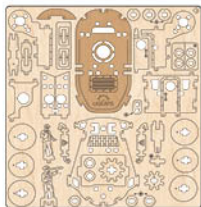

③

2

1

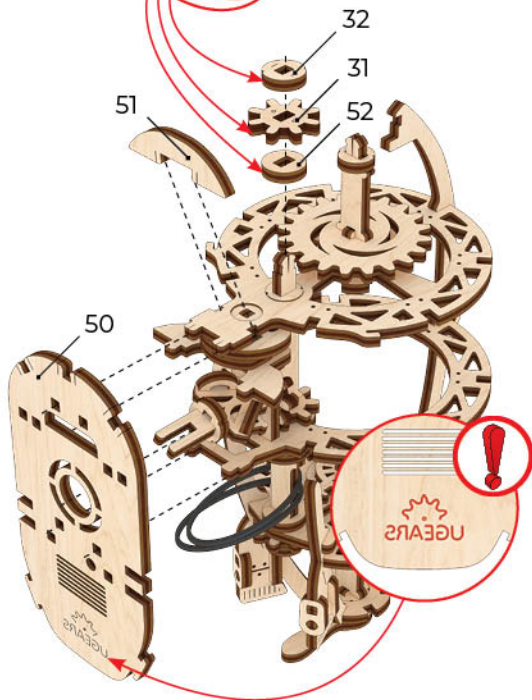
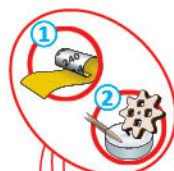
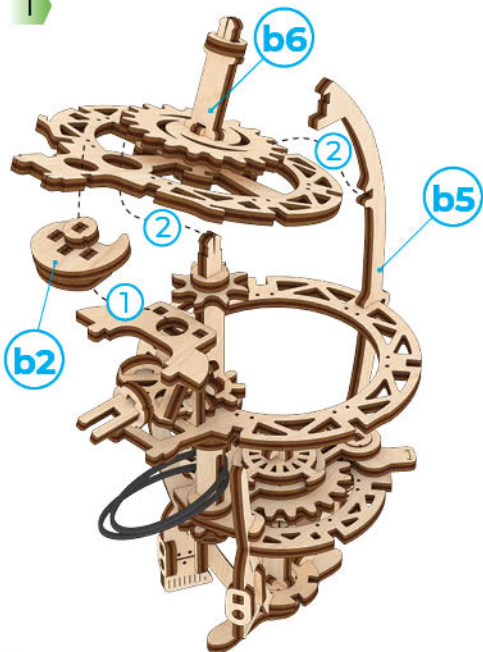

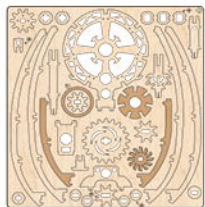

②

3

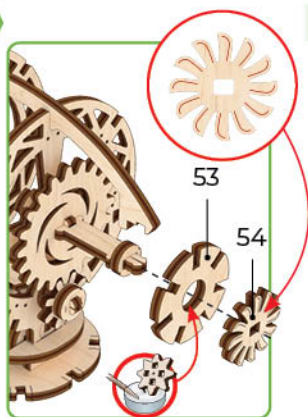

53

54

4

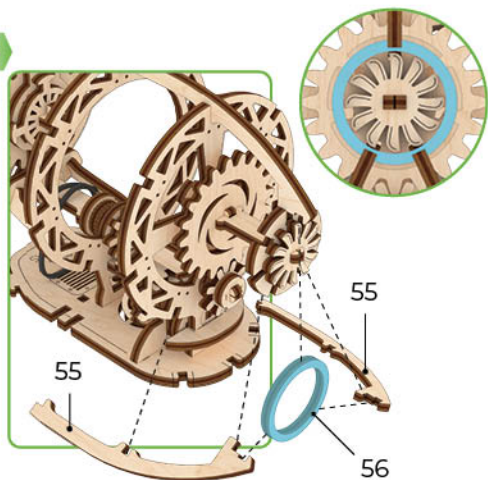

55

56



1

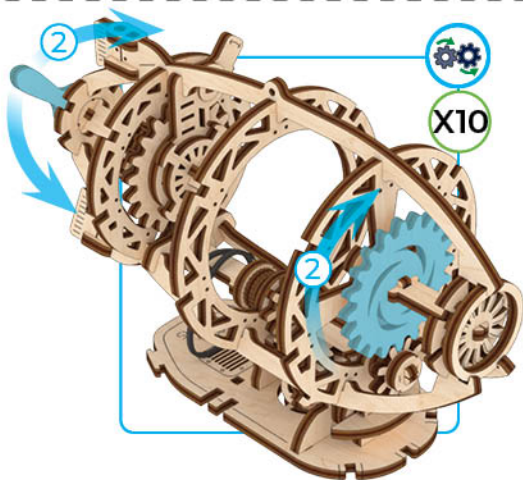

2

2

X10

5

X2

$h \approx 0.06'' / 1,5 \text{ mm}$
 $D \approx 1.57'' / 40 \text{ mm}$

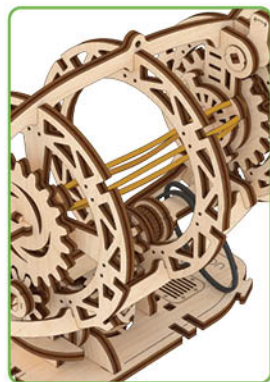
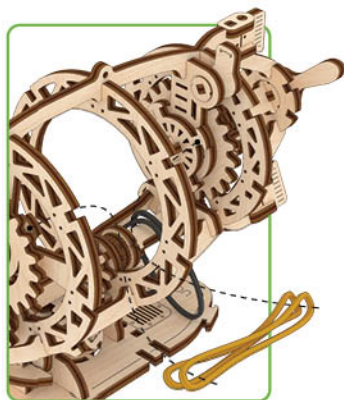
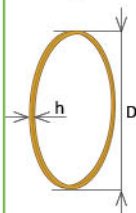

6

X6

$h \approx 0.06'' / 1,5 \text{ mm}$
 $D \approx 1.57'' / 40 \text{ mm}$

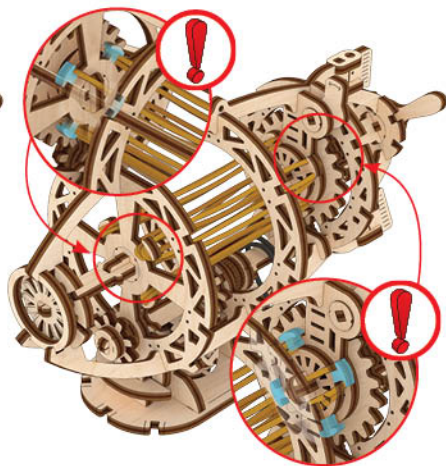
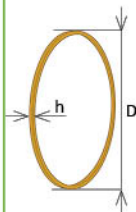

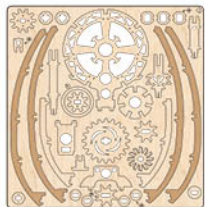

7

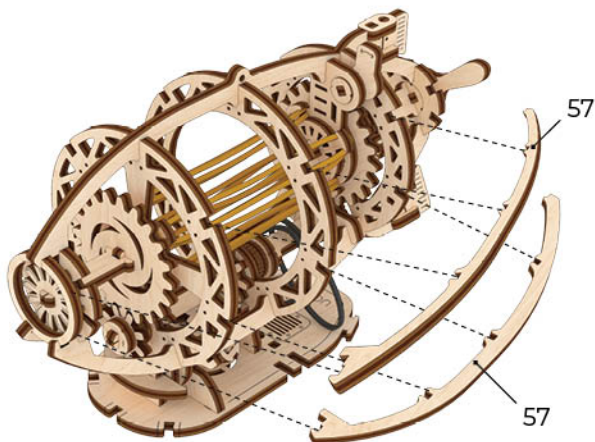

8

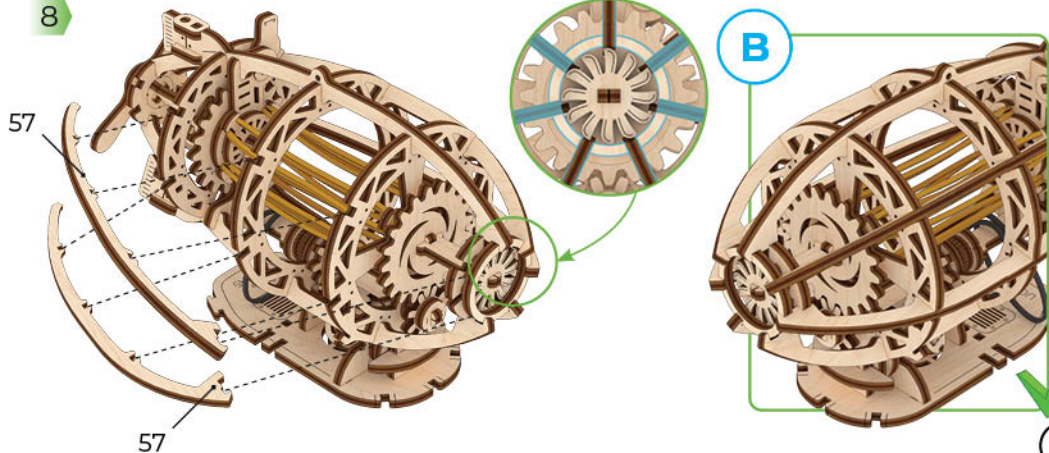

17

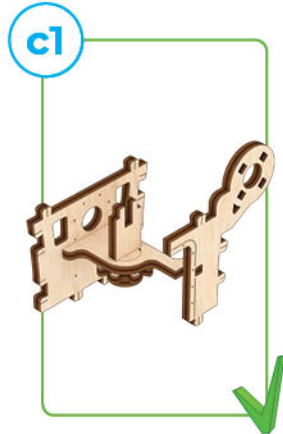
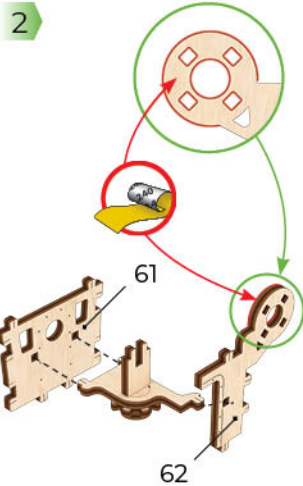
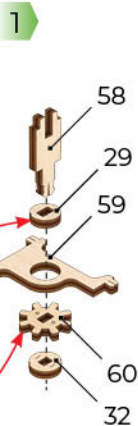
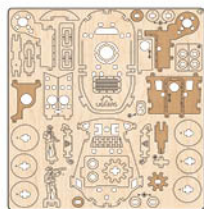
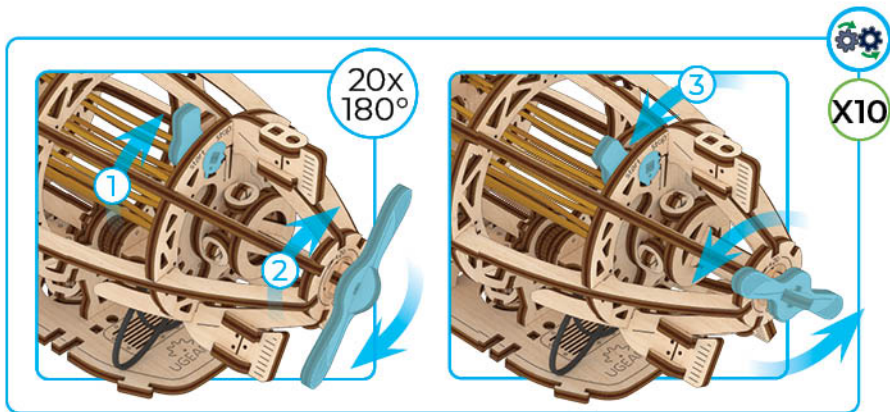

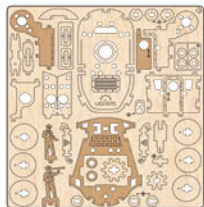

1

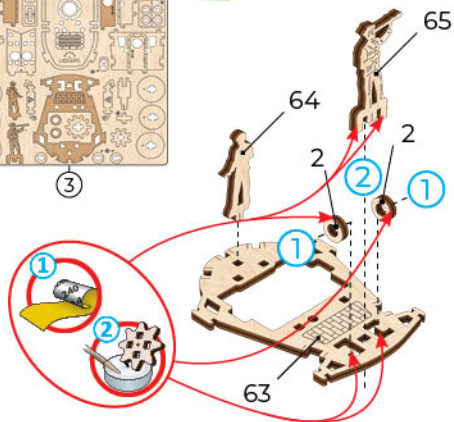

2

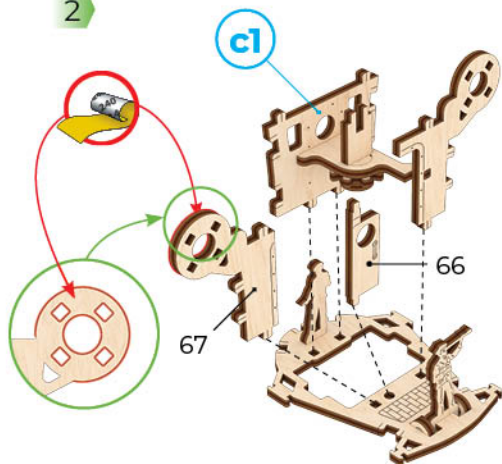

3

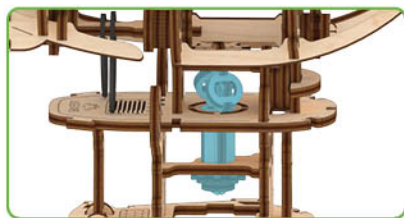

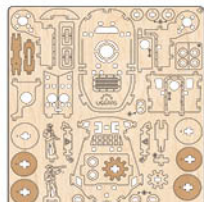
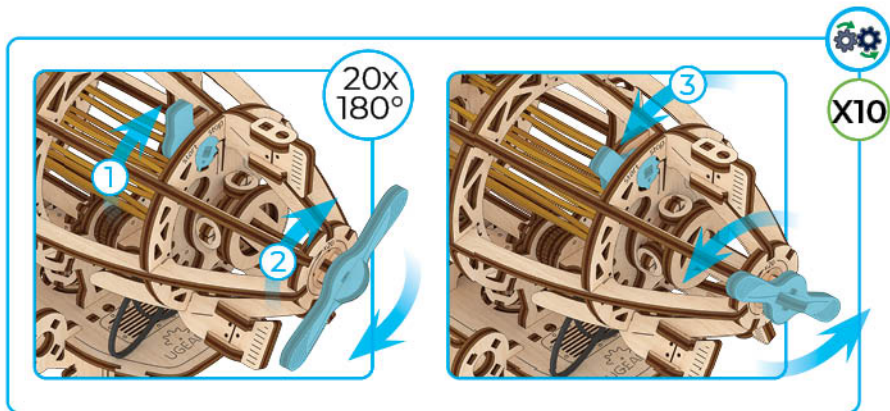

3

4

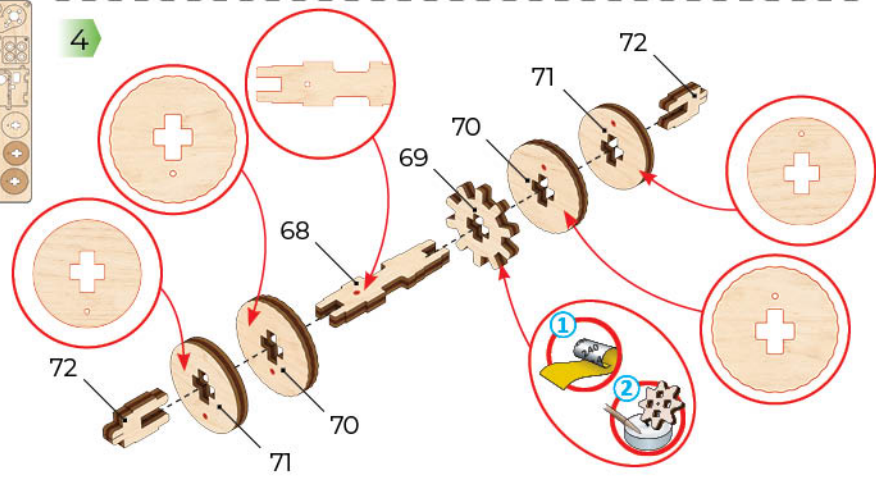

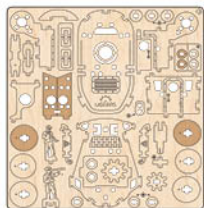

5

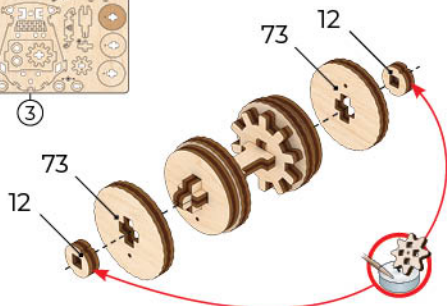

6

X2

$h \approx 0.12'' / 3 \text{ mm}$
 $D \approx 0.78'' / 20 \text{ mm}$

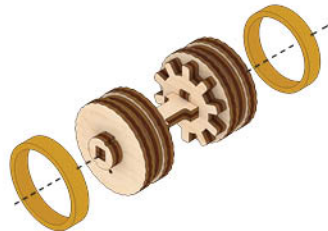
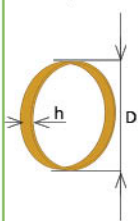

7

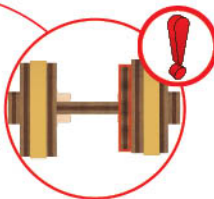
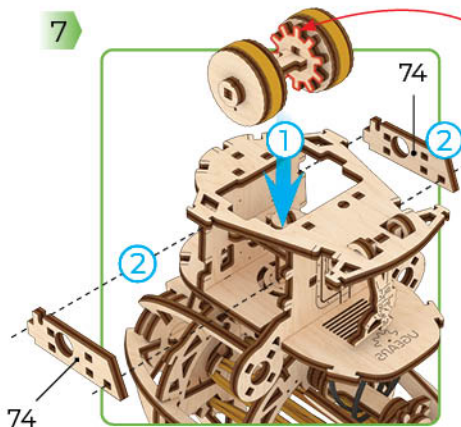



8

4

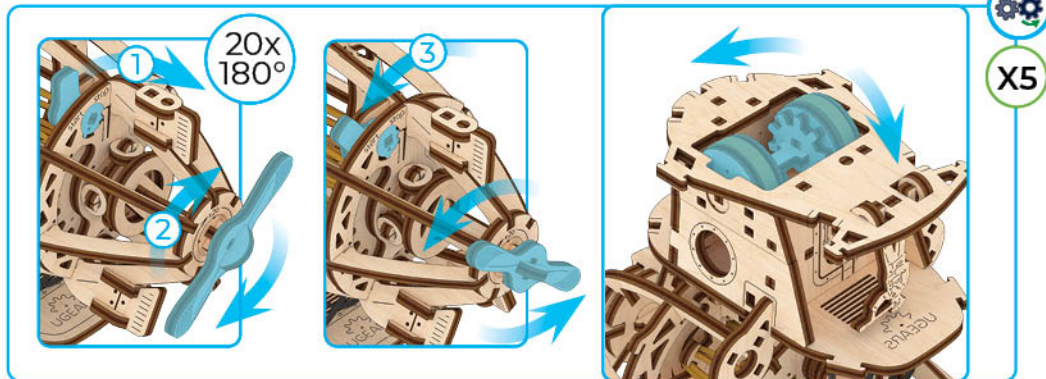
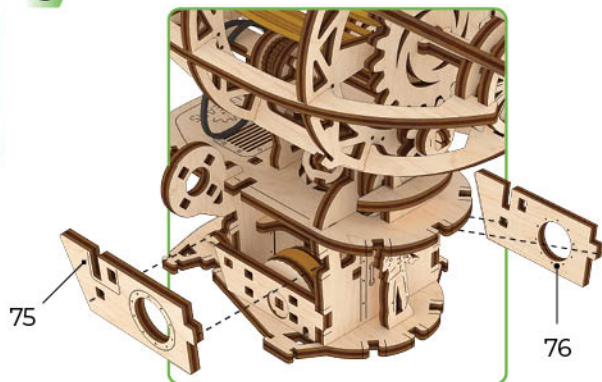

9

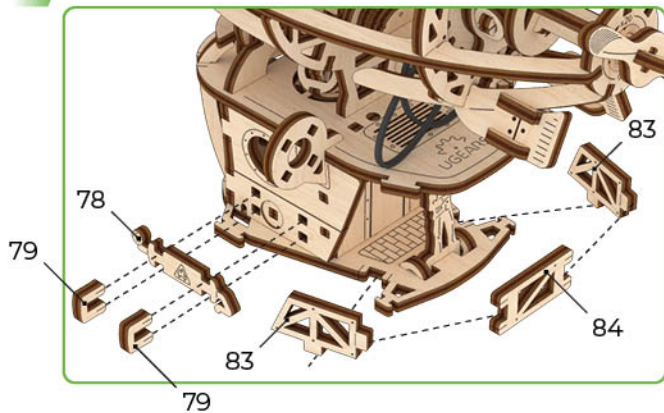
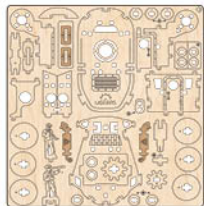

10

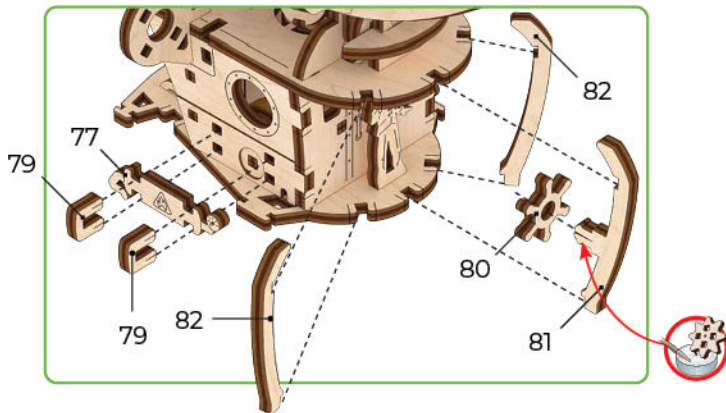



4

11



12

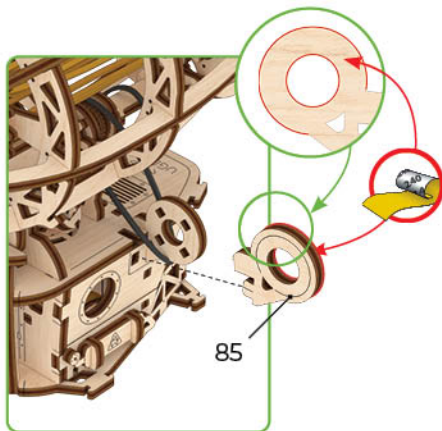

85

13

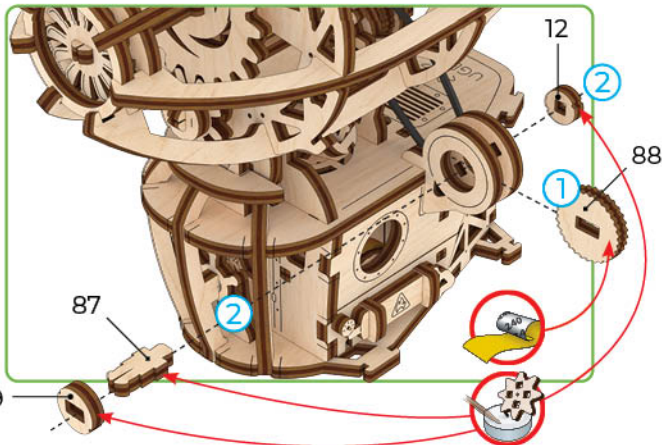

87

2

2

1

88

12

24

29

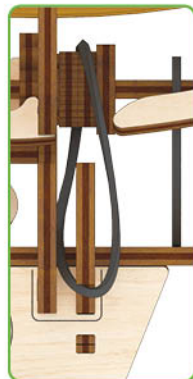



4

14

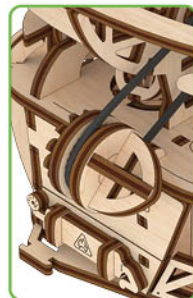
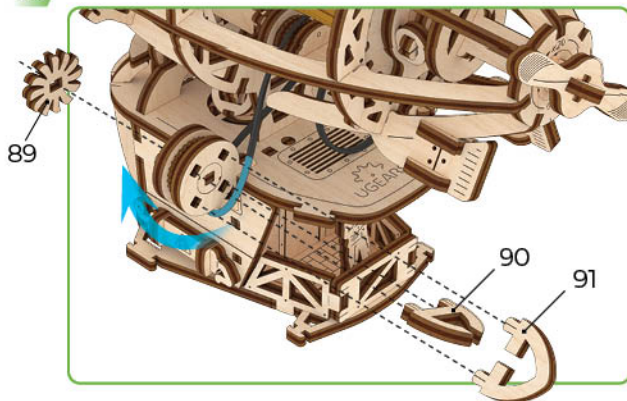

15

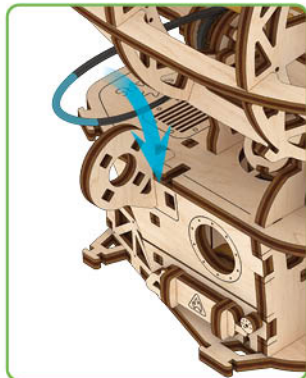

16

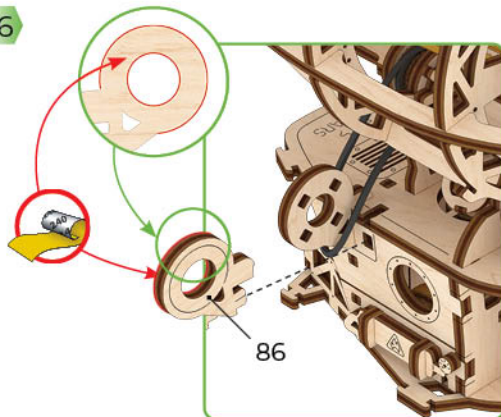



17

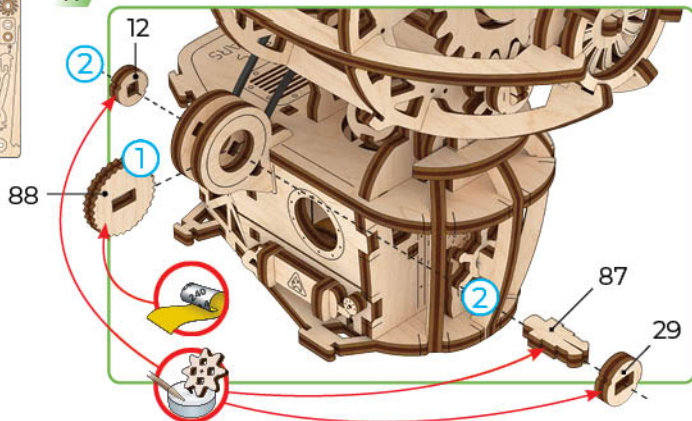

18

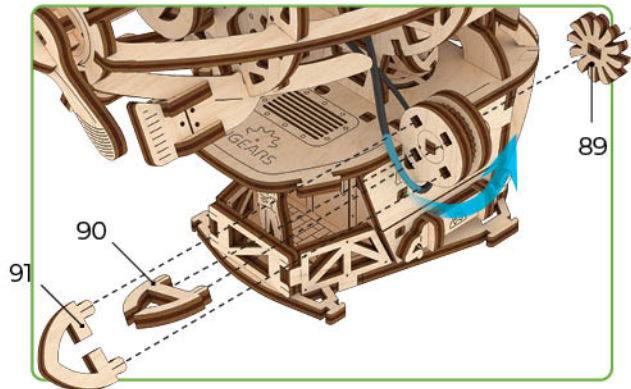

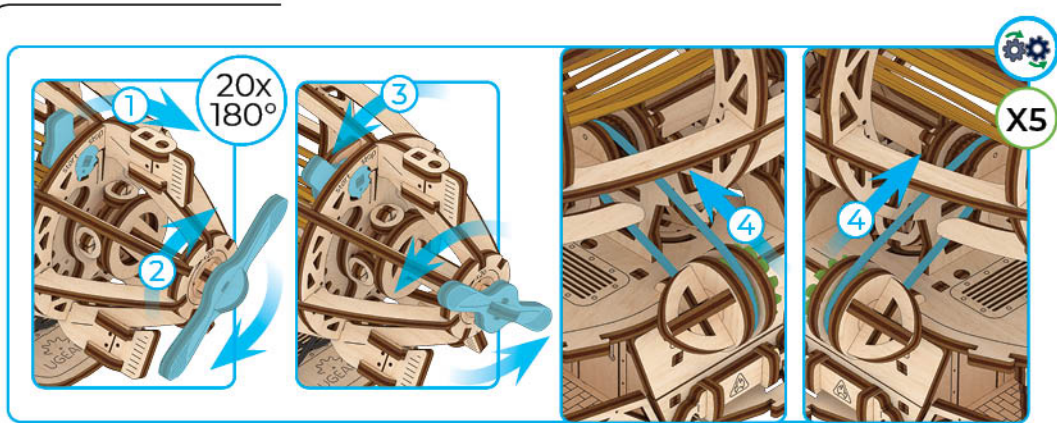

19

$h \approx 0.06'' / 1,5 \text{ mm}$
 $D = 2.36'' / 60 \text{ mm}$

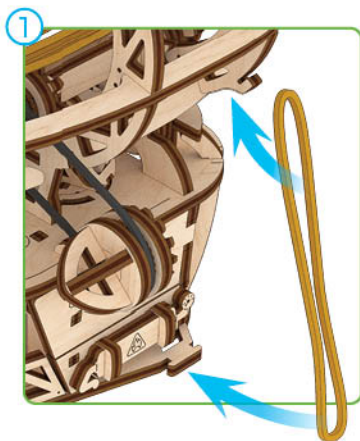
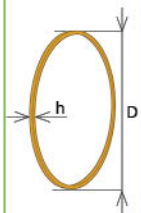

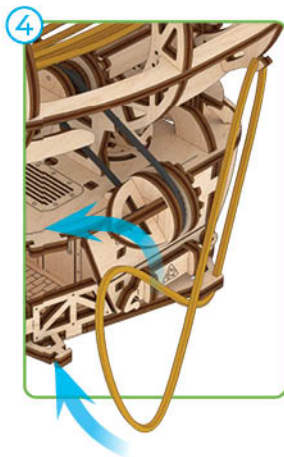
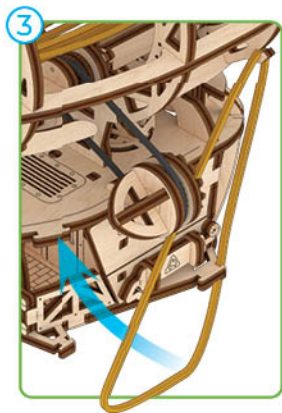

20

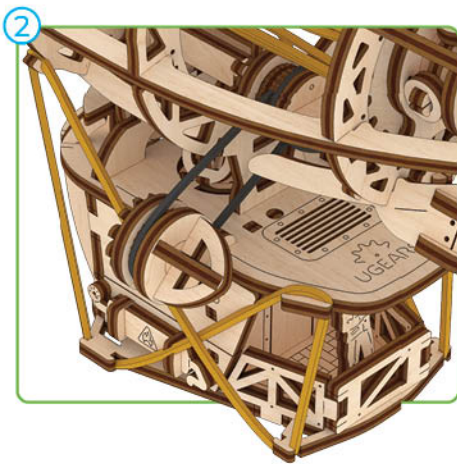
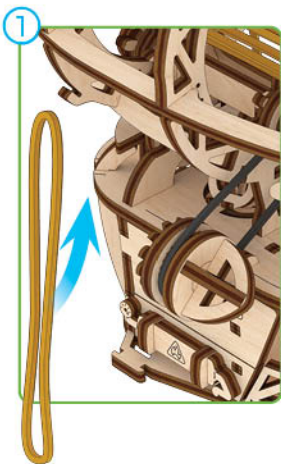
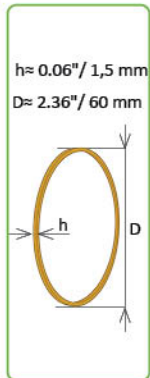

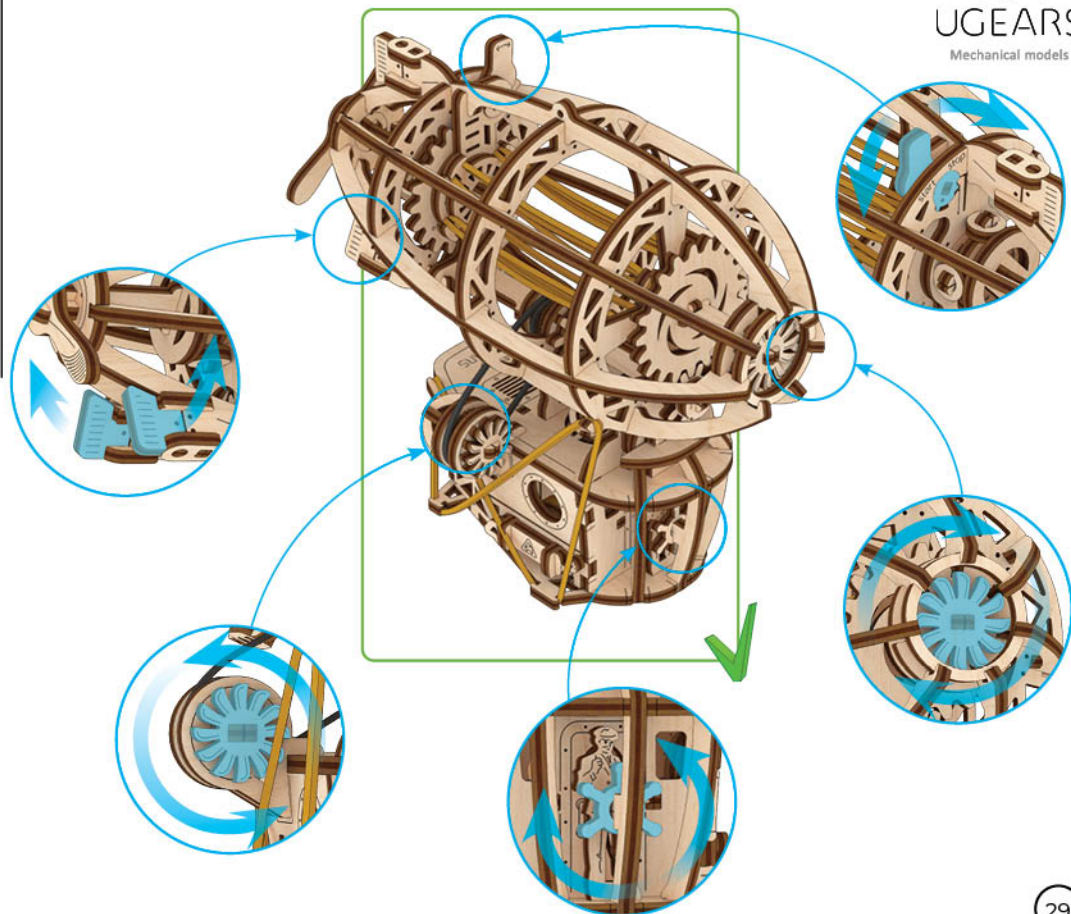

YOU MAY ALSO LIKE

Mini biplane

84

PARTS

2
HOUR

ASSEMBLY
TIME

EASY

LEVEL



Mad Hornet Airplane

354

PARTS

8
HOURS

ASSEMBLY
TIME

ADVANCED

LEVEL



YOU MAY ALSO LIKE

Hot Rod Furious Mouse



207

PARTS

4
HOUR

ASSEMBLY
TIME

EASY

LEVEL



Winged Sports Coupe



262

PARTS

4
HOURS

ASSEMBLY
TIME

EASY

LEVEL





Mechanical models

ENG Thanks for following along on this journey with us.

UKR Дякуємо, що ви пройшли цей шлях з нами.

FRA Merci denous avoir accompagnés tout au long de ces étapes.

DEU Vielen Dank, dass Sie diesen Weg mit uns gegangen sind.

SPA Gracias por haber recorrido el camino con nosotros.

ITA Grazie per aver fatto uesto percorso con noi.

JPN UGEARSをご利用いただきありがとうございます

CHI 感谢您参与有趣的模型装配过程。

POR Obrigado por seguir nesta jornada conosco.

POL Dziękujemy, że razem z nami pokonałeś tę drogę!

KOR UGEARS 와 함께해 주셔서 감사합니다.

ugearsmodels.com

ENG Customer support **UKR** Служба підтримки

FRA Service client **DEU** Kundendienst

SPA Servicio al cliente **ITA** Servizio di supporto

JPN お客様窓口 **CHI** 客户支持 **POR** Atendimento ao cliente

POL Wsparcie klienta **KOR** 고객센터

customerservice@ugearsmodels.com